

# HDL5

DIRECTIONAL  
SOLENOID VALVE

320 bar 120 l/min

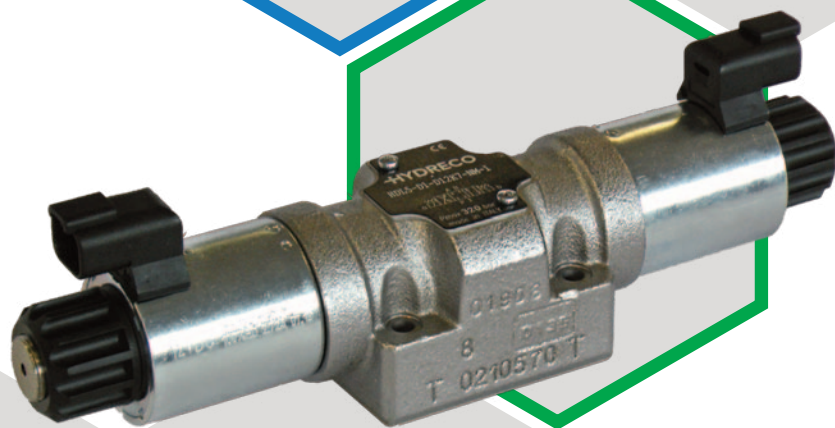

**INTRODUCTION**

The HDL5 valves are solenoid directional valves, direct operated, with porting pattern compliant to ISO 4401-05 standards.

These valves are supplied with a zinc-nickel plating making them the perfect choice for mobile and environmental applications that require better protection.

Salt spray resistance up to 600 h (test according to UNI EN ISO 9227 and UNI EN ISO 10289 tests and standards).

The valve body is made with high strength iron castings with internal passages designed to minimize pressure drop.

**FLUIDS**

Use mineral oil-based hydraulic fluids HL or HM type, according to ISO 6743-4. For these fluids, use NBR seals. For fluids HFDR type (phosphate esters) use FPM seals (code V). For the use of other kinds of fluid such as HFA, HFB, HFC, please consult our technical department.

Using fluids at temperatures higher than 80 °C (180 °F) causes the accelerated degradation of seals as well as the fluid physical and chemical properties.

From a safety standpoint, temperatures above 55 °C (130 °F) are not recommended.

**OPERATING PARAMETERS**

<b>MAXIMUM OPERATING PRESSURE</b>	P - A - B ports	320 bar	4600 psi
	T port	210 bar	3000 psi
<b>FLOW RATE</b>		120 l/min	31.7 gpm
<b>MOUNTING SURFACE</b>		ISO 4401-05-04-0-05 NFPA D05	
<b>STEP RESPONSE</b>	0 → 100%	70 ÷ 100 ms	
	100 → 0%	15 ÷ 20 ms	
<b>WEIGHT</b>	single solenoid	2.4 kg	5.3 lbs
	double solenoid	3 kg	6.6 lbs
<b>RANGE TEMPERATURES</b>	ambient	-20 to +50 °C	-4 to +122 °F
	fluid	-20 to +82 °C	-4 to +180 °F
<b>FLUID VISCOSITY</b>	range	10 - 400 cSt	60 - 1900 SUS
	recommended	25 cSt	120 SUS
<b>FLUID CONTAMINATION</b>		ISO 4406:1999 class 20/18/15	

**HYDRAULIC SYMBOLS (TYPICAL)**

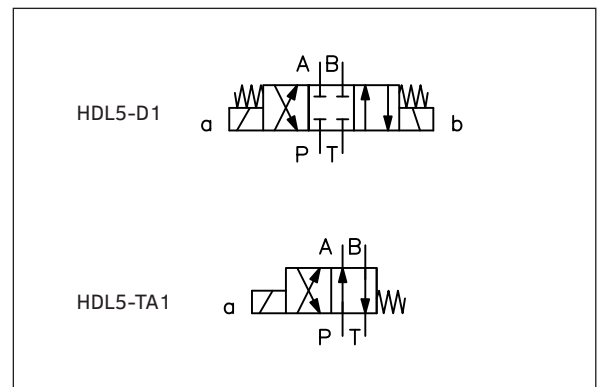

# HDL5 - ■ ■ - ■ ■ - ■ ■ - 1

design mark

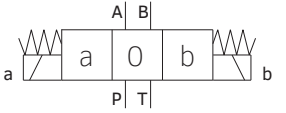
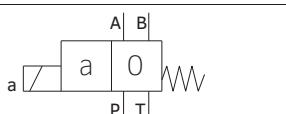
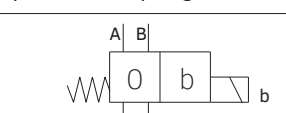
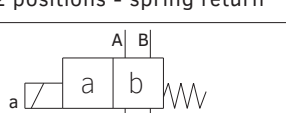
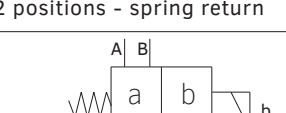
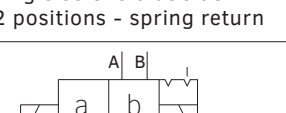
FUNCTION	
<b>D</b>	 <p>double solenoid 3 positions - spring centred</p>
<b>A</b>	 <p>single solenoid at side A 2 positions - spring return</p>
<b>B</b>	 <p>single solenoid at side B 2 positions - spring return</p>
<b>TA</b>	 <p>single solenoid at side A 2 positions - spring return</p>
<b>TB</b>	 <p>single solenoid at side B 2 positions - spring return</p>
<b>K</b>	 <p>double solenoid and detent 2 positions</p>

VOLTAGE	
<b>D12</b>	12 V DC solenoid
<b>D14</b>	14 V DC solenoid
<b>D24</b>	24 V DC solenoid
<b>D26</b>	26 V DC solenoid
<b>D28</b>	28 V DC solenoid
<b>D48</b>	48 V DC solenoid
<b>D110</b>	110 V DC solenoid
<b>D00</b>	without coils

COIL *	
<b>K1</b>	DIN 43650
<b>K2</b>	AMP Junior
<b>K7</b>	DT04-2P 'deutsch'
<b>WK1</b>	DIN 43650 zinc-nickel plated
<b>WK7</b>	DT04-2P 'deutsch' zinc-nickel plated
<b>WK7D</b>	DT04-2P 'deutsch' zinc-nickel plated with diode

MANUAL OVERRIDE	
<b>M</b>	built-in with the tube, pin ( <b>standard</b> )
<b>B</b>	built-in with the tube, boot protected ( <b>standard</b> with WK* coils)
<b>K</b>	knob, turning

\* See table at page 6 for coil availability

SPOOL
See next page

SEAL	
<b>N</b>	NBR ( <b>standard</b> )
<b>V</b>	Viton

### CODE EXAMPLES:

HDL5 - D1 - D12K7 - NM - 1  
HDL5 - D1 - D12WK7 - NB - 1



Flow characteristic curves obtained with mineral oil with viscosity of 36 cSt (170 sus) at 50 °C (122 °F) and 24V DC valve; the  $\Delta p$  values are measured between P and T (full loop) valve ports.

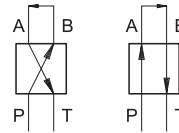

**PRESSURE DROPS  $\Delta p$ -Q**

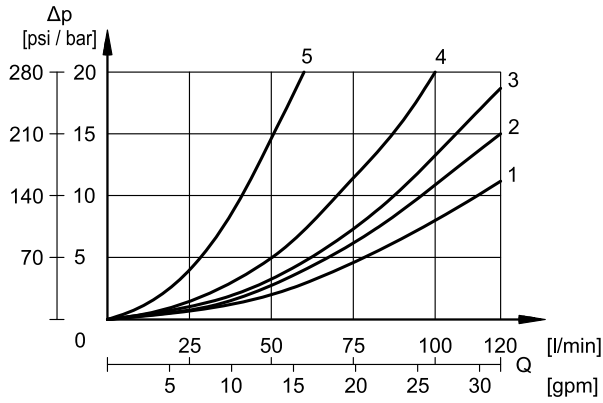

**ENERGIZED POSITION**

TYPE	CURVE			
	P→A	P→B	A→T	B→T
D1, A1, B1	1	1	2	2
D2, A2, B2	1	1	1	1
D3, A3, B3	1	1	1	1
D4, A4, B4	4	4	4	4
K1	2	2	2	2
TA1	2	2	3	3
TA2	2	2	1	1
TA3	3	3	-	-

**DE-ENERGIZED POSITION**

TYPE	CURVE		
	A→T	B→T	P→T
D2	-	-	1
D3	5	5	-
D4	-	-	1

**PERFORMANCE CURVES - STANDARD OPERATION**

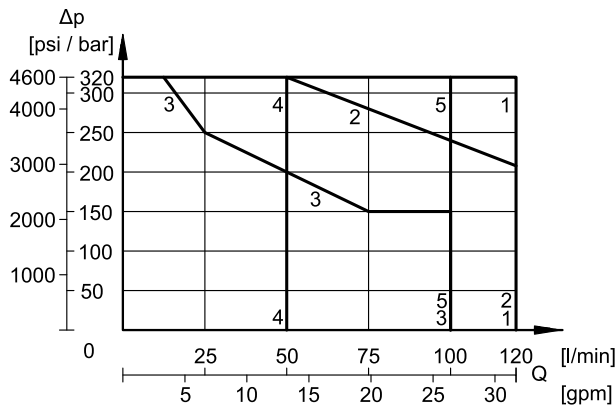

TYPE	CURVE
D1, D2, K1	1
TA2	2
D3	3
D4	4
TA1, TA3	5

**PERFORMANCE CURVES - 3-PORTS OPERATION**

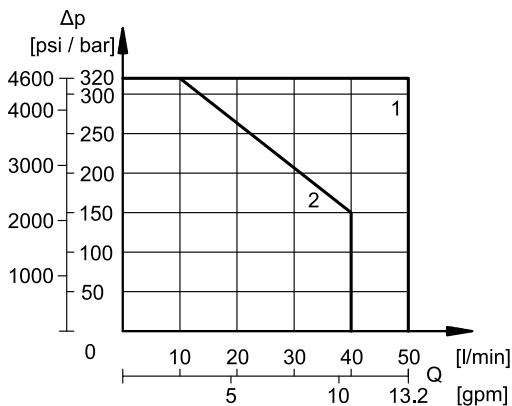

TYPE	CURVE
TA1	1
TA2	2

**ELECTRICAL DATA**

Solenoids are made up of two parts: tube and coil. The tube is threaded into the valve body and includes the armature that moves immersed in oil, without wear. The inner part, in contact with the oil in the return line, ensures heat dissipation.

The coil is fastened to the tube by a retainer, and can be indexed 360°, to suit the clearance space.

It is possible to feed D48 and D110 coils with alternating current (50 or 60 Hz) using connectors with built-in Graetz bridge rectifier. Consider a reduction of the operating limits.

The WK7D coil includes a suppressor diode of pulses for protection from voltage peaks. During the switching the diode significantly reduces the energy released by the winding, by limiting the voltage to 31.4V in the D12 coil and to 58.9 V in the D24 coil.

<b>DUTY CYCLE</b>	100%	
<b>MAXIMUM SWITCH ON FREQUENCY</b>	10,000 cycles/hr	
<b>SUPPLY VOLTAGE FLUCTUATION</b>	± 10% Vnom	
<b>ELECTROMAGNETIC COMPATIBILITY (EMC)</b>	2014/30/EU	
<b>LOW VOLTAGE</b>	2014/35/EU	
<b>PROTECTION CLASS FOR INSULATION</b>	copper wire	class H (180 °C)
	coil	class F (155 °C)

Use coil codes in the table below to order spare parts.

(values ± 10%)

	Nominal voltage [V]	Resistance at 20°C [Ω]	Current consumpt. [A]	Power consumpt [W]	Coil code					
					K1	K2	K7	WK1	WK7	WK7D
<b>D12</b>	12	4,4	2,72	32,7	H1903080	H1903100	H1902940	H1903590	H1903580	H1903600
<b>D14</b>	14	7,2	1.93	27	H1903086					
<b>D24</b>	24	18,6	1,29	31	H1903081	H1903101	H1902941	H1903591	H1903581	H1903601
<b>D26</b>	26,4	21,8	1,21	32				H1903599	H1903589	
<b>D28</b>	28	26	1,11	31	H1903082					
<b>D48</b>	48	78,6	0,61	29,5	H1903083					
<b>D110</b>	110	423	0,26	28,2	H1903464					

Declared IP degrees are intended according to EMC 2014/30/EU, only for both valve and connectors of an equivalent IP degree, installed properly.

WK1, WK7 and WK7D coils reach a better IP degree than standard coils thanks to the zinc-nickel plating and to some constructive measures. The valves with these coils have a salt spray resistance up to 600 hours (test performed according to UNI EN ISO 9227 and assessment test performed according to UNI EN ISO 10289).

Mating connectors are not included in solenoid valves delivery. Connectors for K1 and WK1 coils can be ordered separately.

**K1**

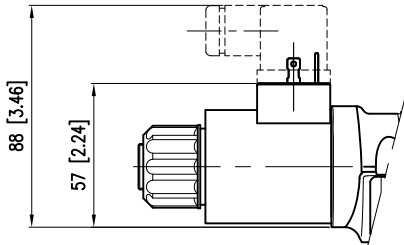

**DIN 43650 (EN 175301-803)**

Mating connectors type ISO 4400 / DIN 43650 (EN 175301-803).

IP degree of electrical connection: IP65

IP degree of whole valve: IP 65

**WK1**

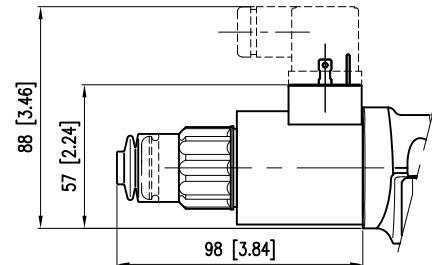

**DIN 43650 (EN 175301-803)**

Zinc-nickel plated coil.

IP degree of electrical connection: IP66

IP degree of whole valve: IP66

The pin for manual override is boot-protected (code B).

**K2**

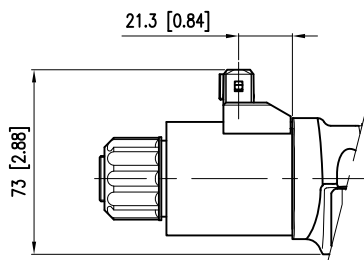

**AMP Junior**

IP degree of electrical connection: IP65/IP67

IP degree of whole valve: IP 65

**K7**

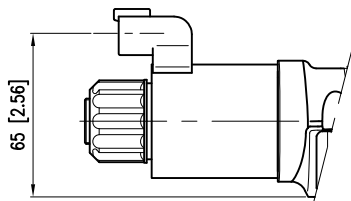

**DEUTSCH DTO4 MALE**

IP degree of electrical connection: IP65/IP67

IP degree of whole valve: IP 65

**WK7 / WK7D**

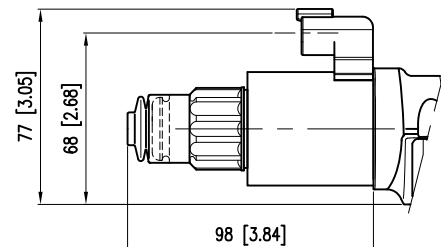

**DEUTSCH DTO4 MALE**

Zinc-nickel plated coil.

IP degree of electrical connection: IP66/IP68/IP69 -

IP degree of whole valve: IP66/IP68/IP69

IP degree according to ISO 20653: IP69K

The pin for manual override is boot-protected (code B).

**HDL5 DOUBLE SOLENOID (K7 COIL)**

dimensions in mm [in]

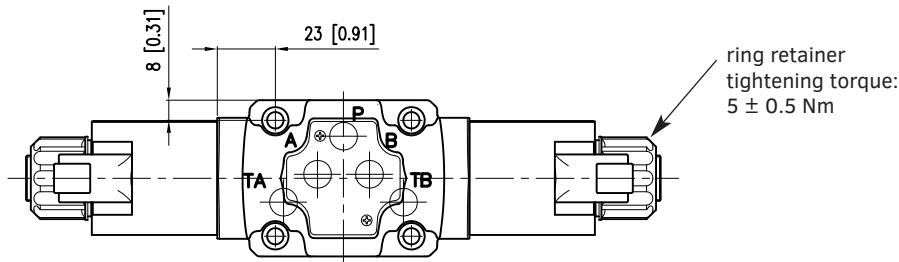
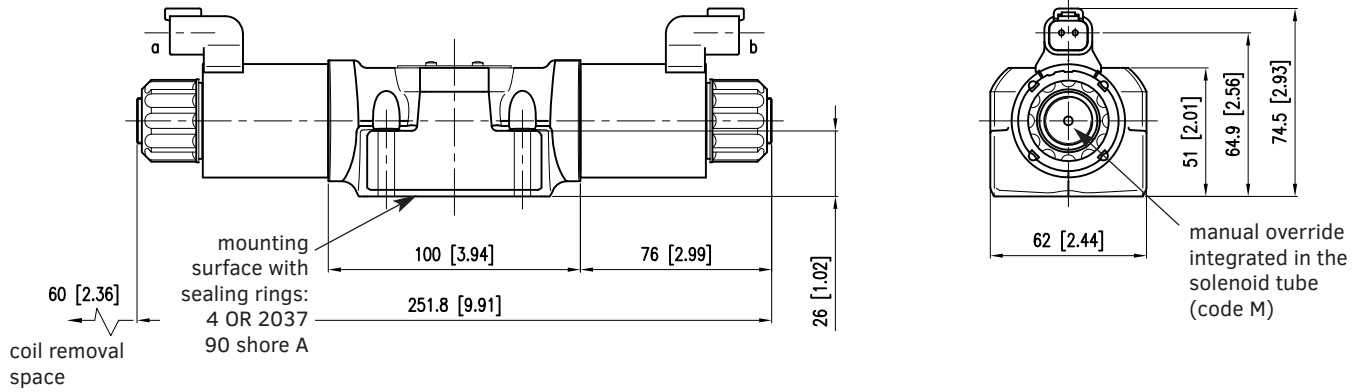

**HDL5 SINGLE SOLENOID SIDE A (K7 COIL)**

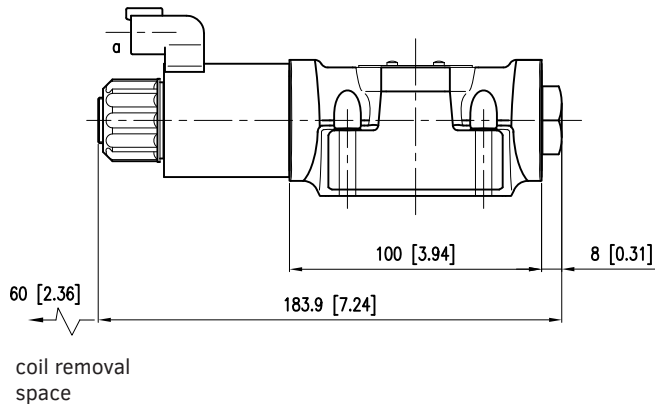

**HDL5 SINGLE SOLENOID SIDE B (K7 COIL)**

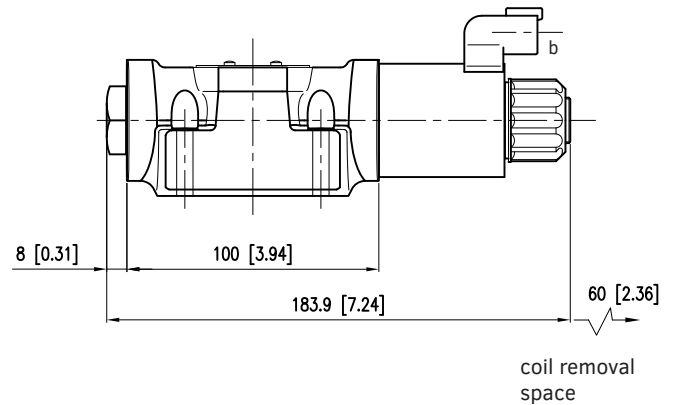

**Fastening bolts:**

4 SHCS M6x35 - ISO 4762 - torque 8 Nm (A 8.8)

**Threads of mounting holes:** M6x10



The standard valve has override pins integrated in the tube.  
The operation of this control must be executed with a suitable tool, carefully not to damage the sliding surface.

Further manual overrides are available, entering the proper code in the model number.

**VERRIDE PINS INTEGRATED THE TUBE, BOOT PROTECTED**

Code B

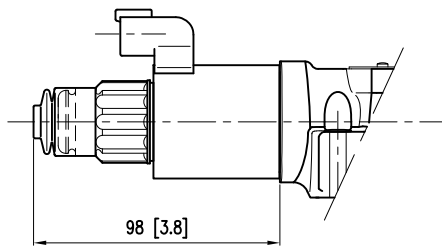

**KNOB, TURNING**

Code K

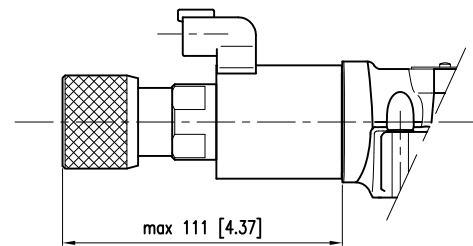

**IP DEGREE TIPS**

The technical reference standard for IP degree is IEC 60529, which classifies and rates the degree of protection provided by equipments and electrical enclosures against intrusions.

The first digit (6) concerns the protection from solid particles (body parts to dust).

The second digit of the IP rating concerns the liquid ingress protection. It indicates three different types of atmospheric agents from which provide protection:

Values from 1 to 6 → water jets.

Values 7 and 8 → immersion.

Value 9 → high pressure and high temperature water jets.

This means that IP66 covers all the lower steps, rating IP68 covers IP67 but not IP66 and lower. Instead, IP69 does not cover any of them. Whether a device meets two types of protection requirements it must be indicated by listing both separated by a slash. (E.g. a marking of an equipment covered both by temporary immersion and water jets is IP66/IP68).

**INSTALLATION**

These valves can be installed in any position without impairing correct operation.

Ensure that there is no air in the hydraulic circuit.

Valves are fixed by means of screws or tie rods on a flat surface with planarity and roughness equal to or better than those indicated in the relative symbols. If minimum values are not observed, fluid can easily leak between the valve and support surface.

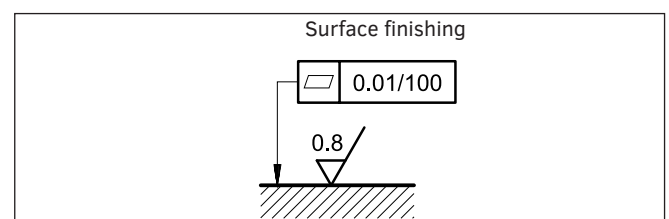

Supported by a worldwide network



## CONTACT INFORMATION

### EMEA

<b>GERMANY</b>	Hydreco Hydraulics GmbH, Straelen (NRW)	☎ +49 283494303-41	✉ info-de@hydreco.com
<b>ITALY</b>	Hydreco Hydraulics Italia Srl, Vignola (MO)	☎ +39 059 7700411	✉ sales-it@hydreco.com
<b>ITALY</b>	Hydreco Hydraulics Italia Srl, Parma (PR)	☎ +39 0521 1830520	✉ sales-it@hydreco.com
<b>ITALY</b>	Hydreco Srl, San Cesario S/P (MO)	☎ +39 059 330091	✉ cylinders@hydreco.com
<b>NORWAY</b>	Hydreco Hydraulics Norway AS, Nittedal	☎ +47 22909410	✉ post-no@hydreco.com
<b>UK</b>	Hydreco Hydraulics Ltd, Poole, Dorset	☎ +44 (0) 1202 627500	✉ info-uk@hydreco.com

### AMERICAS

<b>NORTH/LATIN</b>	Hydreco Inc / Continental Hydraulics Inc, Shakopee (MN)	☎ +1 952 895 6400	✉ sales@conthyd.com
--------------------	---	-------------------	---------------------

### APAC

<b>AUSTRALIA</b>	Hydreco Hydraulics Pty Ltd, Seven Hills (NSW)	☎ +61 2 9838 6800	✉ sales-au@hydreco.com
<b>AUSTRALIA</b>	Hydreco Hydraulics Pty Ltd, Welshpool (WA)	☎ +61 8 9377 2211	✉ reception-wa@hydreco.com
<b>INDIA</b>	Hydreco Hydraulics India Private Ltd, Bangalore	☎ +91 80 67656300	✉ sales-in@hydreco.com