

HQE3

PROPORTIONAL
FLOW CONTROL VALVE,
COMPENSATED

250 bar 40 l/min

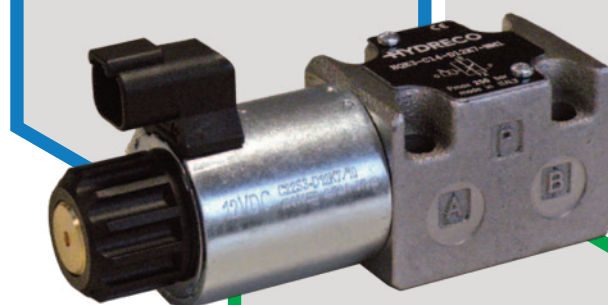

INTRODUCTION

The HQE3 valves are direct operated normally closed proportional flow control valves with pressure compensation, with porting pattern compliant to ISO 6263-03 standards.

These valves regulate flow in a hydraulic circuit. Output flow is directly proportional to the input current to the solenoid.

By closing the residual flow port (P) the valve can also be operated as a 2-way flow control valve. T port in the manifold must always be plugged.

2-way compensators are typically used in circuits supplied by variable volume pumps.

3-way compensators are typically used in circuits with fixed volume pumps. Connect 'P' port to the tank to use the valve as a bypass flow control.

FLUIDS

Use mineral oil-based hydraulic fluids HL or HM type, according to ISO 6743-4. For these fluids, use NBR seals.

For fluids HFDR type (phosphate esters) use FPM seals (code V). For the use of other kinds of fluid such as HFA, HFB, HFC, please consult our technical department.

Using fluids at temperatures higher than 80 °C (180 °F) causes the accelerated degradation of seals as well as the fluid physical and chemical properties.

From a safety standpoint, temperatures above 55 °C (130 °F) are not recommended.

OPERATING PARAMETERS

MAXIMUM OP. PRESSURE	all ports	250 bar	3600 psi
REGULATED FLOW		14 l/min 20 l/min 30 l/min 40 l/min	3.7 gpm 5.3 gpm 8.0 gpm 10.5 gpm
COMPENSATOR SPRING	HQE3-C14	4 bar	58 psi
	HQE3-C30		
	HQE3-C20	8 bar	116 psi
	HQE3-C40		
MINIMUM PRESSURE DROP A TO B	HQE3-C14	10 bar	145 psi
	HQE3-C30		
	HQE3-C20	22 bar	320 psi
	HQE3-C40		

STEP RESPONSE	0 → 100%	< 70 ms	
HYSTERESIS	% of Q max	< 6%	
REPEATABILITY	% of Q max	< ± 1.5%	
VOLTAGE		12V DC 24V DC	
COIL CONNECTION		DIN 43650	DT04-2P
PROTECTION	according IEC 60529	IP65	IP65/67
WEIGHT		1.6 kg	3.5 lbs

RANGE TEMPERATURES:	ambient	-20 to +54 °C	-4 to +130 °F
	fluid	-20 to +82 °C	-4 to +180 °F
FLUID VISCOSITY	range	10 - 400 cSt	60 - 1900 SUS
	recommended	25 cSt	120 SUS
FLUID CONTAMINATION		ISO 4406:1999 class 18/16/13	

HYDRAULIC SYMBOLS

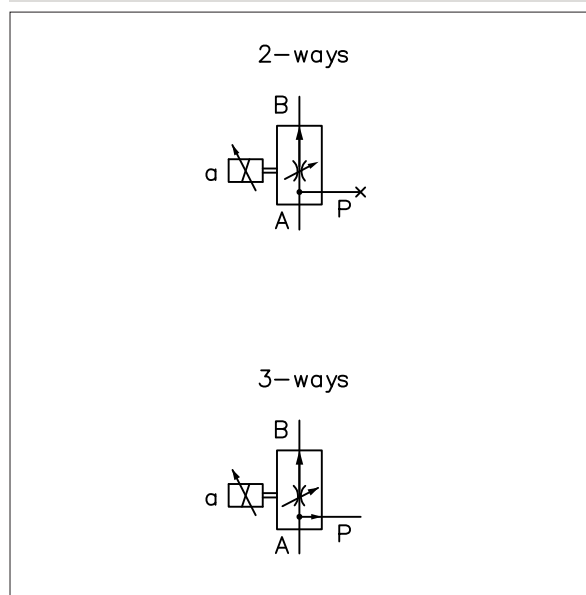

HQE3 - C ■ - ■ ■ - ■ ■ - 1

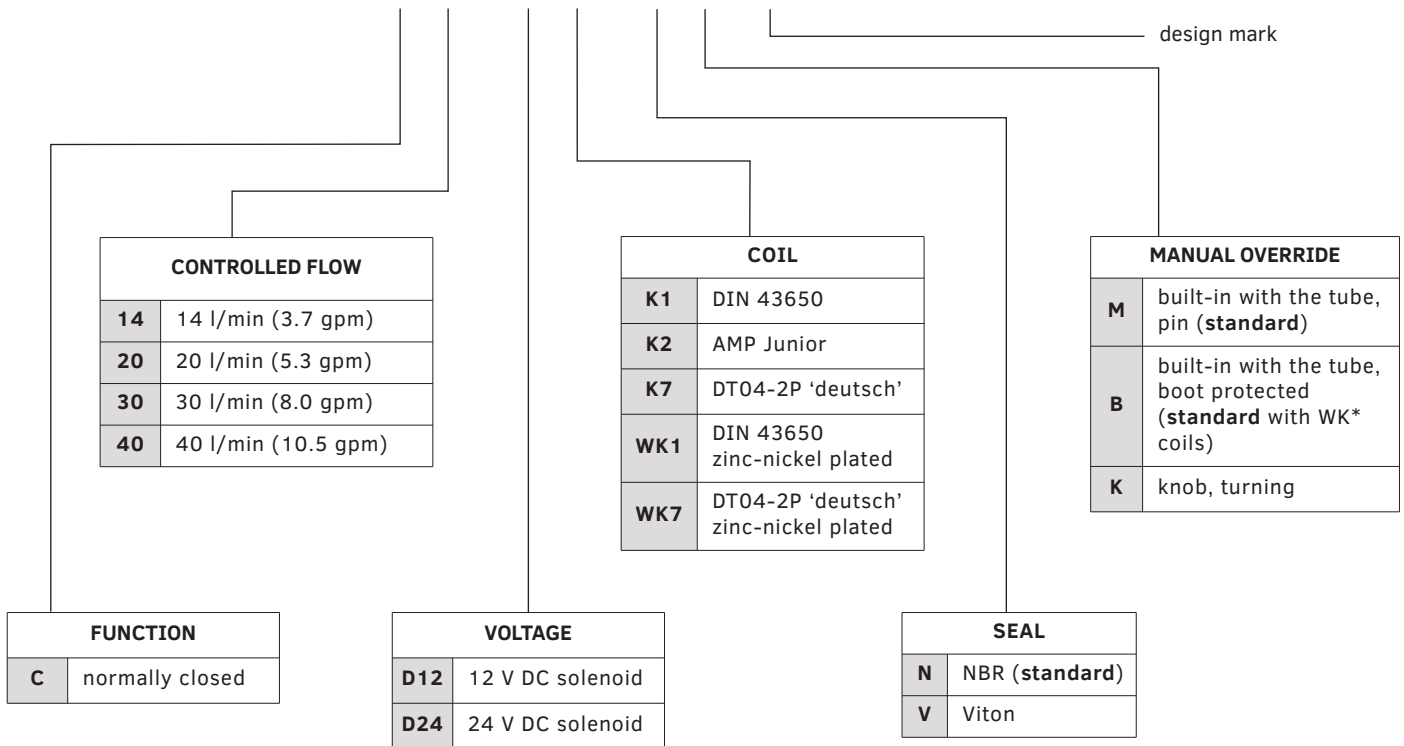

CODE EXAMPLE:

HQE3 - C14 - D12K7 - NM - 1

Typical flow rate characteristics A → B depending on the current supplied to the solenoid (D24 version, maximum current 860 mA, PWM 100 Hz)

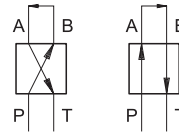

2-WAYS FLOW CONTROL Q = F (COMMAND)

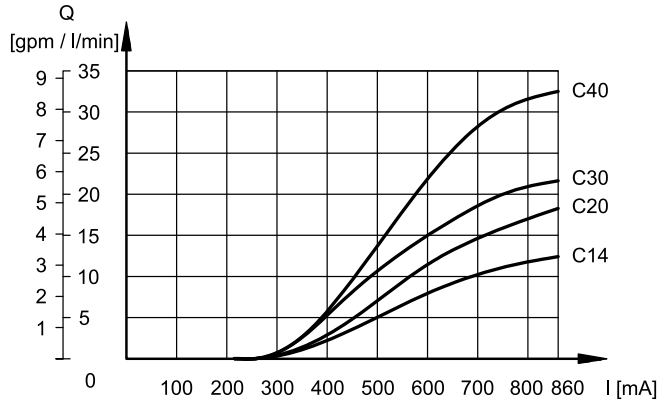

2-WAYS FLOW CONTROL Q = F (PRESSURE IN B)

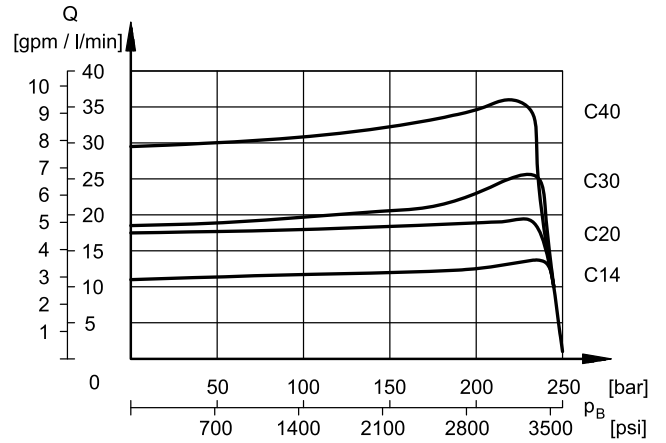

3-WAYS FLOW CONTROL Q = F (COMMAND)

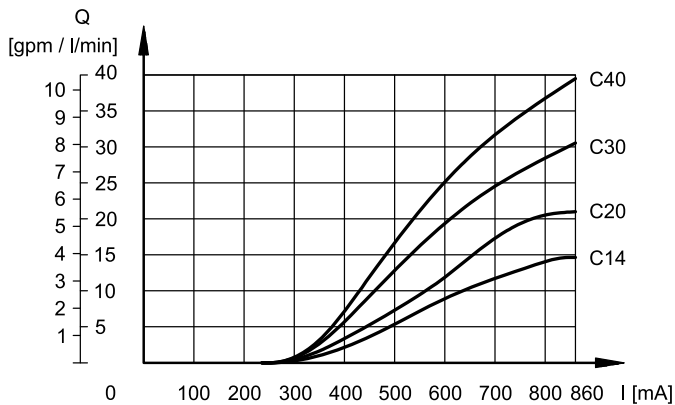

3-WAYS FLOW CONTROL Q = F (PRESSURE IN B)

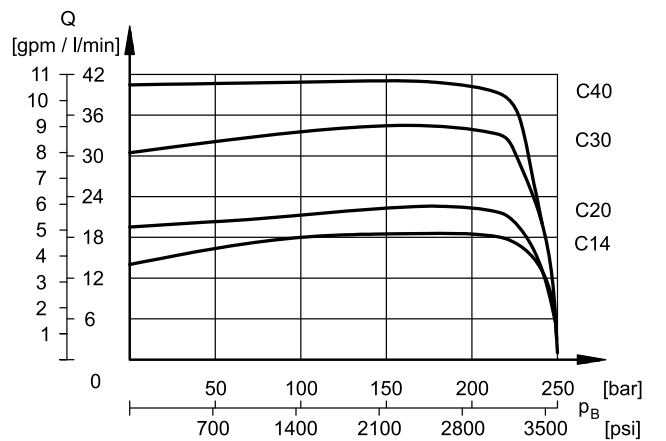

PRESSURE DROPS Δp A→P (Q_B = 0)

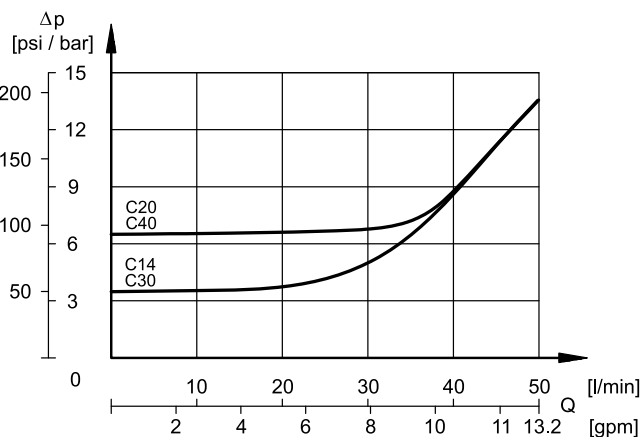

Pressure drops with flow A → P.
 Obtained with Q_B = 0
 (de-energised coil - no current)

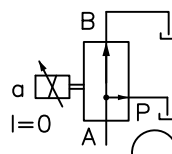

The proportional solenoid consists of tube and coil. The coil is mounted on the tube and fastened to it by a ring retainer.

The coils can be indexed to any position allowing for convenient location of the connector.

DUTY CYCLE	100%	
ELECTROMAGNETIC COMPATIBILITY (EMC)	according to European directive 2014/30/EU	
PROTECTION CLASS FOR INSULATION	copper wire	class H (180 °C)
	coil	class F (155 °C)

	Nominal voltage [V]	Resistance at 20 °C [Ω]	Current at 20 °C. [A]	Coil codes for spare parts				
				K1	K2	K7	WK1	WK7
D12	12	4.4	1.88	H1903080	H1903100	H1902940	H1903590	H1903580
D24	24	18.6	0.86	H1903081	H1903101	H1902941	H1903591	H1903581

Declared IP degrees are intended according to EMC 2014/30/EU, only for both valve and connectors of an equivalent IP degree, installed properly.

WK1 and WK7 coils reach a better IP degree than standard coils thanks to the zinc-nickel plating and to some constructive measures. The valves with these coils have a salt spray resistance up to 600 hours (test performed according to UNI EN ISO 9227 and assessment test performed according to UNI EN ISO 10289).

K1

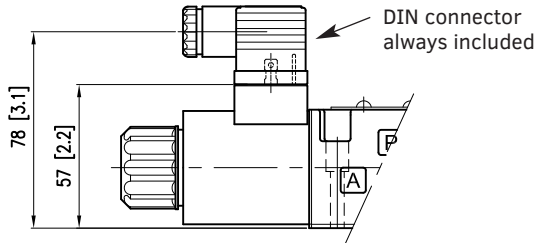

DIN 43650 (EN 175301-803)

IP degree of electrical connection: IP65
 IP degree of whole valve: IP 65

WK1

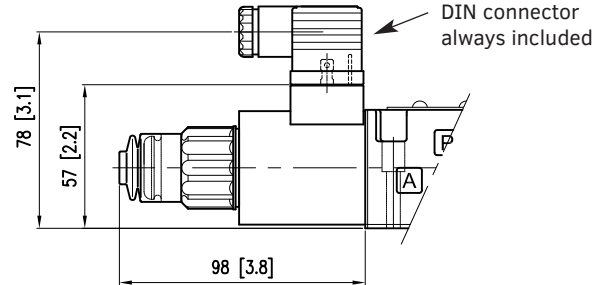

DIN 43650 (EN 175301-803)

Zinc-nickel plated coil.

IP degree of electrical connection: IP66
 IP degree of whole valve: IP66

The pin for manual override is boot-protected (code B).

K2

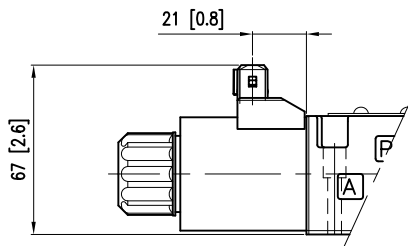

AMP Junior

IP degree of electrical connection: IP65/IP67
 IP degree of whole valve: IP 65

K7

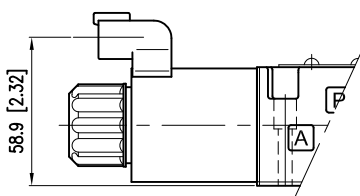

DEUTSCH DT04 MALE

IP degree of electrical connection: IP65/IP67
 IP degree of whole valve: IP 65

WK7

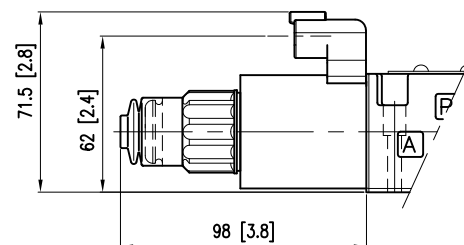

DEUTSCH DT04 MALE

Zinc-nickel plated coil.

IP degree of electrical connection: IP66/IP68/IP69 -
 IP degree of whole valve: IP66/IP68/IP69
 IP degree according to ISO 20653: IP69K

The pin for manual override is boot-protected (code B).

dimensions in mm [in]

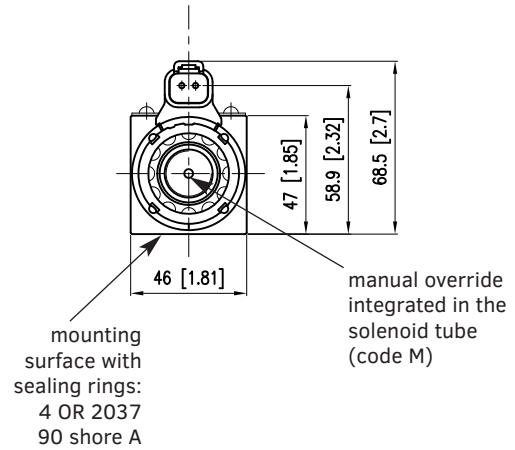
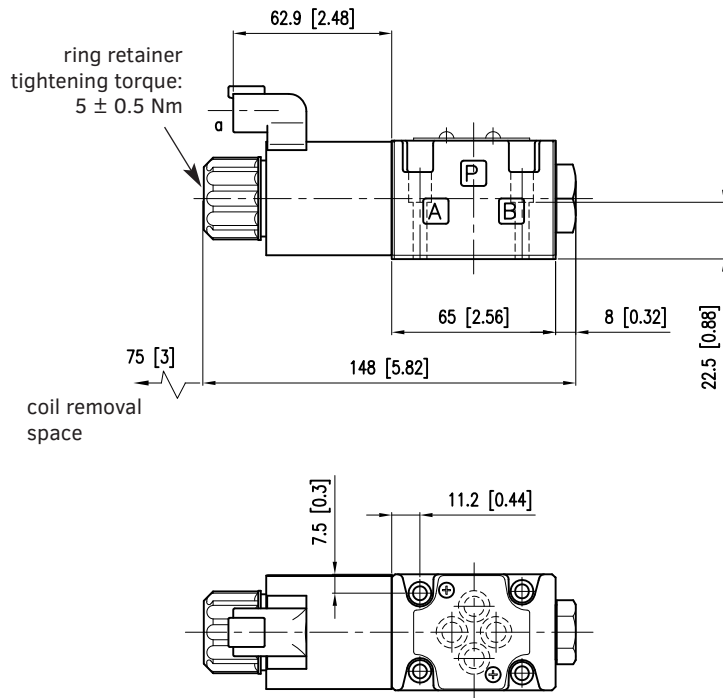

Fastening bolts:

4 SHCS M5x30 - ISO 4762 - torque 5 Nm (A 8.8)

Threads of mounting holes: M5x10

OPERATION DEPENDING ON PORTS IN THE MOUNTING INTERFACE

The valve has all the ports indicated in ISO 6263-03-03-*-97 standard. The correct operation depends on how the mounting interface is realized.

The T port must not be present in the mounting interface.

The P port acts as discharge for residual flow.

If the P port is not even created, the valve works as restrictive compensator, 2-ways.

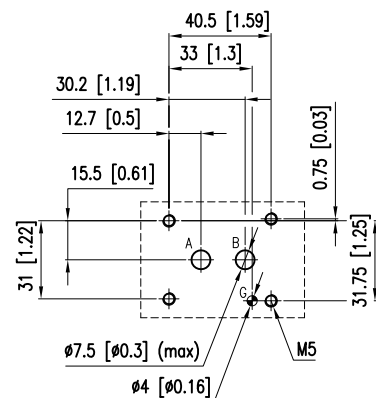
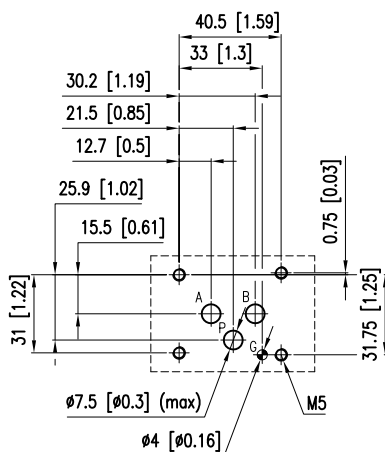
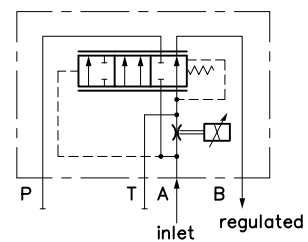
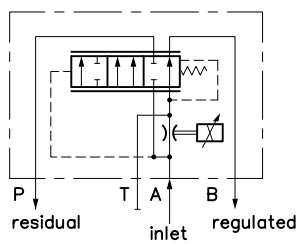

These valves have solenoids whose pin for manual operation is integrated in the tube (code M). Actuate this override by pushing it with a suitable tool, minding not to damage the sliding surface.

Further manual overrides are available, entering the proper code in the model number.

OVERRIDE PINS INTEGRATED THE TUBE, BOOT PROTECTED

Code B

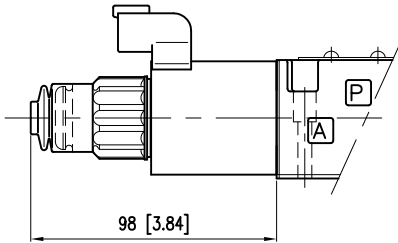

KNOB, TURNING

Code K

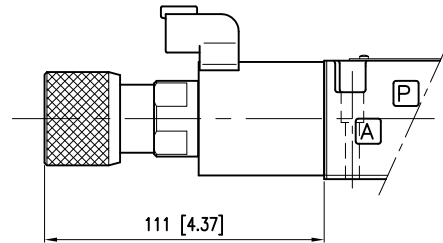

IP DEGREE TIPS

The technical reference standard for IP degree is IEC 60529, which classifies and rates the degree of protection provided by equipments and electrical enclosures against intrusions.

The first digit (6) concerns the protection from solid particles (body parts to dust).

The second digit of the IP rating concerns the liquid ingress protection. It indicates three different types of atmospheric agents from which provide protection:

Values from 1 to 6 → water jets.

Values 7 and 8 → immersion.

Value 9 → high pressure and high temperature water jets.

This means that IP66 covers all the lower steps, rating IP68 covers IP67 but not IP66 and lower. Instead, IP69 does not cover any of them. Whether a device meets two types of protection requirements it must be indicated by listing both separated by a slash. (E.g. a marking of an equipment covered both by temporary immersion and water jets is IP66/IP68).

INSTALLATION

These valves can be installed in any position without impairing correct operation.

Ensure that there is no air in the hydraulic circuit.

Valves are fixed by means of screws or tie rods on a flat surface with planarity and roughness equal to or better than those indicated in the relative symbols. If minimum values are not observed, fluid can easily leak between the valve and mounting surface.

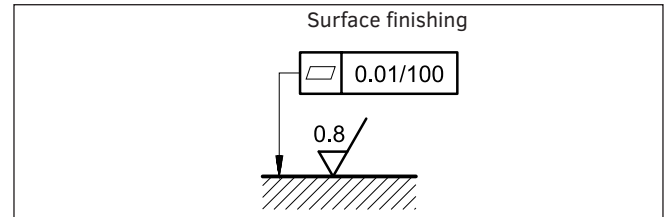

Supported by a worldwide network



CONTACT INFORMATION

EMEA

GERMANY	Hydreco Hydraulics GmbH, Straelen (NRW)	+49 283494303-41	info-de@hydreco.com
ITALY	Hydreco Hydraulics Italia Srl, Vignola (MO)	+39 059 7700411	sales-it@hydreco.com
NORWAY	Hydreco Hydraulics Norway AS, Nittedal	+47 22909410	post-no@hydreco.com
UK	Hydreco Hydraulics Ltd, Poole, Dorset	+44 (0) 1202 627500	info-uk@hydreco.com

AMERICAS

USA	Hydreco Inc, Rock Hill (SC)	+1 704 295 7575	sales-us@hydreco.com
LATIN AMERICA		+1 704 572 6266	sales-es@hydreco.com

APAC

AUSTRALIA	Hydreco Hydraulics Pty Ltd, Seven Hills (NSW)	+61 2 9838 6800	sales-au@hydreco.com
AUSTRALIA	Hydreco Hydraulics Pty Ltd, Smeaton Grange (NSW)	+61 2 4647 6577	au-smeatongrange@hydreco.com
AUSTRALIA	Hydreco Hydraulics Pty Ltd, Welshpool (WA)	+61 8 9377 2211	reception-wa@hydreco.com
INDIA	Hydreco Hydraulics India Private Ltd, Bangalore	+91 80 67656300	sales-in@hydreco.com